

Atlas LCR45

Passive Component Impedance Meter
Model LCR45

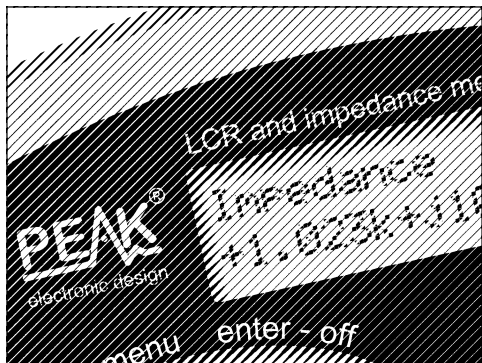

Designed and manufactured with pride in the UK

User Guide

© Peak Electronic Design Limited 2002-2014

In the interests of development, information in this guide is subject to change without notice - E&OE



Want to use it now?

We understand that you want to use your Atlas LCR45 now. The unit is ready to go, but please make sure that you do read through pages 3-4.

Contents	Page
Introduction	3
Important Notices	4
Introductory notes about impedance	5
User Interface	7
Using your LCR45	8
Component Display	8
Impedance Display	9
Admittance Display	10
Magnitude and Phase Display	11
Modes and Settings.....	12
Frequency Mode Selection	14
Testing Capacitors	15
Capacitance Ranges	16
Inductance Ranges	17
Probe Compensation	18
Taking care of your LCR45	20
Self Tests.....	21
Appendix A – Display Units	22
Appendix B – Accessories	23
Appendix C – Auto Component Identification Criteria	24
Appendix D – Technical Specifications	26
Appendix E – Troubleshooting	27
Appendix F – Statutory Information	28

Introduction

The Atlas LCR45 is an enhanced handheld instrument capable of performing detailed analysis of passive components such as inductors, capacitors and resistors.

As well as standard component identification and value measurement, the LCR45 can provide a detailed impedance analysis of your component.

The LCR45 can be used in a fully automatic mode, or a number of manual modes, giving you an ideal combination of speed and flexibility.

Both the component type and test frequency can be set to automatic or manual modes.

In all modes, the LCR45 provides detailed measurement data including:

- Component type.
- Component value in real engineering units.
- Secondary component value (such as DC resistance of inductors).
- Test frequency used.
- Complex impedance measurement (*real* and *imaginary* portions).
- Complex admittance measurement (*real* and *imaginary* portions).
- Magnitude and Phase of the impedance measurement.

Additional features include:

- Fast start.
- Continuous fluid measurements (with hold function).
- Comprehensive probe compensation measurement.
- Enhanced measurement resolution.
- Enhanced compensation for component parasitics such as core losses, dielectric losses etc.
- Simple menu system.
- Non-volatile user settings.

Important Notices

WARNING:

This instrument must NEVER be connected to powered equipment/components or equipment/components with any stored energy (e.g. charged capacitors).

Failure to comply with this warning may result in personal injury, damage to the equipment under test, damage to the LCR45 and invalidation of the manufacturer's warranty. Non-destructive overload situations are stored in the non-volatile memory within the LCR45 to help Peak with repair diagnostics.

“Analysis of discrete, unconnected components is recommended.”

 The LCR45 is designed to provide accurate and reliable information for the majority of supported component types (inductors, capacitors and resistors) as described in the technical specifications. Testing of other component types or component networks may give erroneous and misleading results.

Introductory notes about impedance

All passive components (inductors, capacitors and resistors) have an impedance. Impedance typically has the units of Ohms. It is a combination of the component's resistive and reactive characteristics.

For resistors, the impedance is usually dominated by its DC resistance and this will largely stay constant over a fairly wide range of frequencies.

Inductors and capacitors however, will exhibit an impedance (still measured in Ohms) that is highly dependent on frequency.

Additionally, inductive and capacitive elements further complicate matters by exhibiting a voltage across them that is not in phase with the current through them.

All of these effects can be described by measuring the “Complex Impedance” of a component. Despite the word “Complex”, it is neat way of combining the impedance (in Ohms) of a component with the current/voltage phase that the component exhibits into a single “complex number”.

For example, a 220 μ H inductor may have an impedance of:

$$\mathbf{Z = 11.6 + j276.5\ Ohms\ at\ 200kHz}$$

The first number (11.6) is the *Real* part of the complex number and represents the resistive element of the component at the current test frequency. That could be DC winding resistance, ferrite core losses and other “lossy” parasitics.

The second number, (276.5) prefixed with j, is the *Imaginary* part of the complex number and represents the reactance of the component (often given the symbol of X).

Complex impedance can be illustrated on an Argand Diagram, showing the *imaginary* (reactive) part on the vertical axis and the *real* (resistive) part on the horizontal axis. This is an ideal way of visualising the magnitude and phase of the impedance.

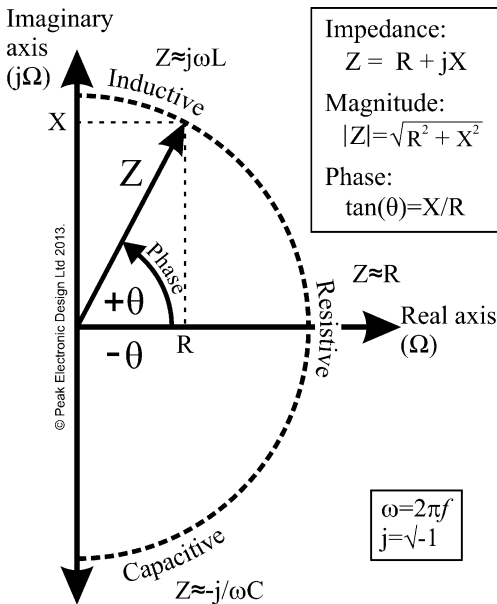

It is not necessary to fully understand Complex Impedance to make good use of the LCR45. All of the detailed calculations are carried out automatically for you, and you are presented with as much or as little of the results as you need.

Further information regarding “Complex Impedance” can be seen here:

http://en.wikipedia.org/wiki/Electrical_impedance#Complex_impedance

User Interface

Button functions of the LCR45 are designed to be intuitive and efficient. If you find yourself in a menu that you don't want, just wait a few seconds and you'll be returned to the normal operation mode.

Generally, unless otherwise stated, the first function printed above a button on the instrument is obtained by a brief press and the second function is obtained by a longer press:

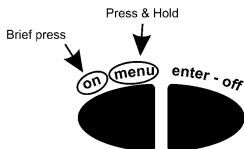

Power On

If your instrument is off, simply press the **on-menu** button to power up.

Power Off

The LCR45 will automatically turn off its own power after 60 seconds of no activity. The unit determines that no activity is taking place if there are no button presses and no internal measurement range changes.

If you wish, you can manually turn off your LCR45 by pressing and holding the **enter-off** button.



Display Hold Function

You can Hold (Pause) the displayed measurements in any of the measurement screens by briefly pressing **on-menu**.



When in HOLD mode, the letter **H** will be displayed. Press **on-menu** again to resume measurements.

Using your LCR45

Normal Use – Fully Auto Mode

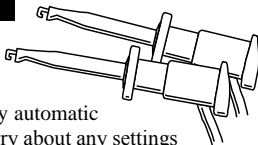

The LCR45, by default, is set to operate in fully automatic mode. In this mode the user doesn't need to worry about any settings as these are automatically determined.

If you wish, you can change the operating modes to allow the manual selection of component measurement type and/or test frequency. This is dealt with on page 11 of this user guide.

To power-up, press the **on-menu** button. After the brief power-up screen, the current operating mode will be displayed for a few seconds.

```
Current mode:
Auto LCR Auto F
```

If you want to skip the mode summary screen (shown here) then briefly press **on-menu** button.

The LCR45 will then continue to the “Component Identification” display and start to perform its measurements continuously. It may take a few measurement updates for the unit to derive the best operating conditions for the component being tested.

Component Display

The detected component type, the test frequency and the component value(s) will be shown continuously. During this time, you're free to move the probes from one component to another and observe the measurements.

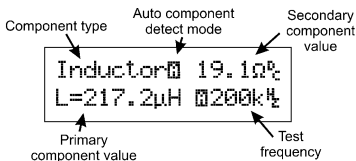

Impedance Display

While measurements are being made, you can switch to a different display mode by pressing **enter-off** for further information about the component's impedance at the current test frequency.

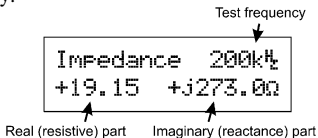

This is displayed as a complex number, comprising of a *real* (resistive) part and an *imaginary* (reactive) part that is prefixed with j.

The complex number displayed can be very useful if you want to use the impedance of your component in some other calculations. Remember that most spreadsheet programs can deal directly with complex numbers and therefore open up all manner of possibilities for using the true complex impedance of your component. Impedance, when in complex number form, can be used in the same way as simple resistance when dealing with series, parallel or series/parallel networks.

How the LCR45 uses Reactance

For inductors, you will generally see a positive *imaginary* (reactance) number. The LCR45 calculates inductance from that reactance figure. Reactance of an inductor is $2\pi fL$.

Calculating the inductance from its reactance figure enables the LCR45 to reduce the influence of winding resistance on readings.

The *real* part of the impedance display will largely consist of the DC winding resistance but the figure may be different to the measured DC resistance. This is because other aspects of the inductor (such as core losses) will influence the *real* part of the impedance at frequencies other than DC. Core losses cannot normally be seen at DC.

Admittance Display

Admittance is the inverse of the Complex Impedance. It can be considered in the same way that *conductance* is the inverse of *resistance*.

Impedance consists of *resistance* and *reactance*.

Admittance consists of *conductance* and *susceptance*.

Admittance has the units of Siemens (also known as Mhos).

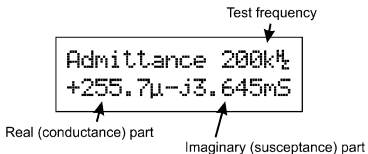

The imaginary part of the admittance is known as *susceptance*.

How the LCR45 uses Susceptance

The LCR45 uses the value of susceptance to calculate capacitance. Susceptance of a capacitor is $2\pi fC$.

Calculating the capacitance from its susceptance figure enables the LCR45 to reduce the influence of dielectric dissipation and parallel leakage on readings.

Over-range Values

Sometimes you may see over-range or erratic values for the impedance or admittance measurements.

An open circuit can render an extremely high value of Impedance (real and/or imaginary parts) and is difficult to mathematically resolve. Similarly, a very low impedance part (such as a short circuit) will result in a very high Admittance measurement that is also difficult to mathematically resolve. This is not an indication of a measurement problem.

Magnitude and Phase Display

Pressing **enter-off** again will take you to a different representation of the component's impedance, the Magnitude and Phase display.

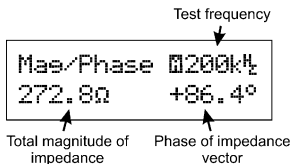
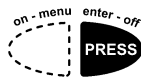

This display is useful for gauging how close your component is to a theoretical “ideal” inductor, capacitor or resistor.

Ideal capacitor:	-90° phase
Ideal inductor:	+90° phase.
Ideal resistor:	0° phase.

It is perfectly normal to see phase values that suggest the component is not “ideal”. Even a small loss in an inductor can have significant influence on the measured phase. Additionally, measurement resolution (particularly at the edges of the LCR45 measurement ranges) can result in non-ideal phase values.

The example shown above illustrates a component that is largely inductive at the test frequency used.

Remember that the magnitude of the impedance is the Pythagorean addition of the real and imaginary parts of the component's impedance (not the arithmetic sum).

$$|Z| = \sqrt{R^2 + X^2} \text{ Ohms}$$

This display mode is not available if testing capacitors at DC.

Selecting Measurement Screen

Earlier pages have introduced the different measurement types available, each selected in turn by briefly pressing the **enter-off** button. To summarise the measurement screens:

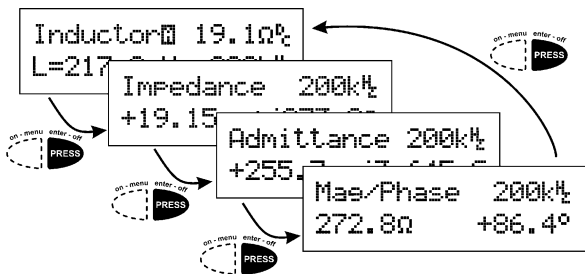

Modes and Settings

If you want to change the operational mode and/or settings, then you need to press and hold the **on-menu** button for a second or two.

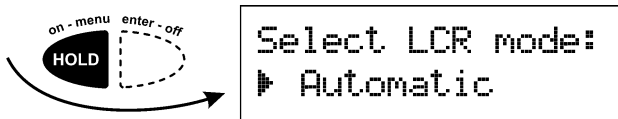

The currently active mode is shown with the **▶** symbol. You can cycle through all the modes available by briefly pressing the **on-menu** button. This is illustrated on the next page.

LCR45 Operation Mode Selection

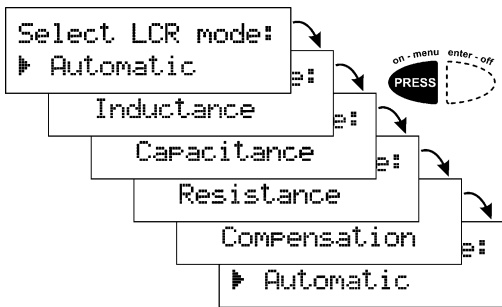

As you can see in the above illustration, each press of the **on-menu** button takes you through all the available modes and then back round again.

Automatic – In this mode, the LCR45 will attempt to determine the component type being analysed and display the appropriate component description. If you encounter any components that are incorrectly identified, you may wish to select one of the dedicated component modes below.

Inductance – Regardless of the measurement characteristics of the component under test, the LCR45 will be forced to base its calculations on the standard inductor model. If you're testing a component that is not an inductor (such as a capacitor for example) then you can expect very strange results.

Capacitance – Selecting this mode will force the LCR45 to assume you're testing a component that is capacitive regardless of the measured characteristics. You may see unusual results if you test non-capacitive components in this mode.

Resistance – This measurement mode will cause the LCR45 to use only DC for its measurements and only display the resulting DC resistance of the component under test.

When you've found your desired mode, press the **enter-off** button to store the setting.



Test Frequency Mode Selection

When the LCR operation mode has been selected, you may be prompted to select your desired test frequency mode.

You will not be asked to select a test frequency mode if you previously selected **Resistance** for the LCR operation mode as that is fixed to DC.

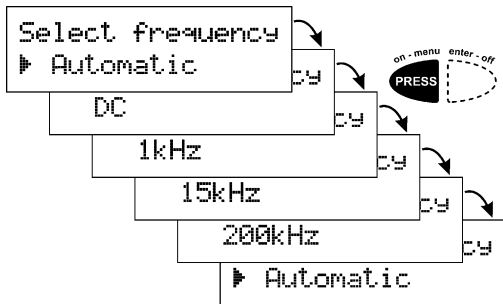

Automatic – The LCR45 will attempt to use the most appropriate test frequency to suit the component being tested. This is generally the best option for most requirements. It will automatically and dynamically select between DC, 1kHz, 15kHz and 200kHz.

DC – This option is available if you previously selected **Capacitance** for the measurement mode, this is ideal for large capacitances such as electrolytics (generally $>7\mu\text{F}$).

1kHz, 15kHz, 200kHz – Selecting a fixed test frequency is particularly useful if you know that the component under test is designed for a specific frequency range (such as audio frequencies for example). Please be aware that the measurement range and the measurement resolution will be influenced by the chosen test frequency.

When you've found your desired frequency mode, press the **enter-off** button to store the setting.



Testing Capacitors

In automatic mode, the LCR45 uses one of two different methods to analyse capacitors, AC impedance analysis for low value capacitors (less than about $7\mu\text{F}$) and DC charge analysis for larger capacitors (about $7\mu\text{F}$ to $10000\mu\text{F}$).

The test method used is confirmed on the component identification display by means of the DC, 1kHz, 15kHz or 200kHz test frequency figure.

Be patient when testing large value capacitors, it may take a second or two depending on the capacitance.

 Capacitors (particularly electrolytics) can store enough charge that may cause damage to the LCR45.

An electrolytic capacitor can even develop its own stored charge that may be sufficient to cause damage to the LCR45 even after it has been temporarily discharged. This is a characteristic known as “Soakage”.

It is vitally important that you ensure the capacitor is fully discharged (ideally for several seconds) to minimise the possibility of damage to the unit.

If you are unsure, measure the voltage across the capacitor using a suitable volt meter before applying the capacitor to the LCR45.

 Generally, tantalum capacitors and electrolytic capacitors are polarised. The LCR45, however, uses a maximum of 1V to test the capacitor and so polarity of the test probes is usually unimportant.

Capacitance Ranges

The following chart illustrates the recommended ranges of capacitance measurement covered by each test frequency in the LCR45.

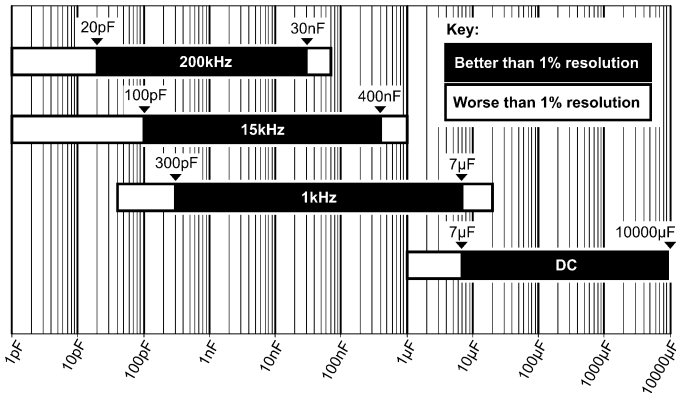

Measuring capacitance outside of the black bands will result in degraded measurement resolution (possibly worse than 1% of the measured value).

Measuring capacitance outside of the white bands may not be possible and could result in unexpected readings.

If the frequency mode is set to **Automatic**, the measured capacitance should lie comfortably within the relevant band. If the automatically selected frequency cannot be correctly determined then it may be necessary to manually select an appropriate test frequency.

Inductance Ranges

The following chart illustrates the recommended ranges of inductance measurement covered by each test frequency in the LCR45.

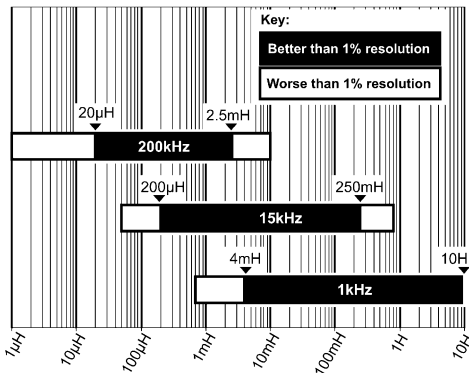

Measuring inductance outside of the black bands will result in degraded measurement resolution (possibly worse than 1% of the measured value).

Measuring inductance outside of the white bands may not be possible and could result in unexpected readings.

If the frequency mode is set to **Automatic**, the measured inductance should lie comfortably within the relevant band. If the automatically selected frequency cannot be correctly determined then it may be necessary to manually select an appropriate test frequency.

Probe Compensation

If you change the probes on your LCR45, it is good practice to run through the compensation procedure. This ensures that the probes' own inductance, capacitance and resistance are automatically taken into account for subsequent measurements.

Invoke the LCR operation mode menu by pressing and holding the **on-menu** button for a second or two.

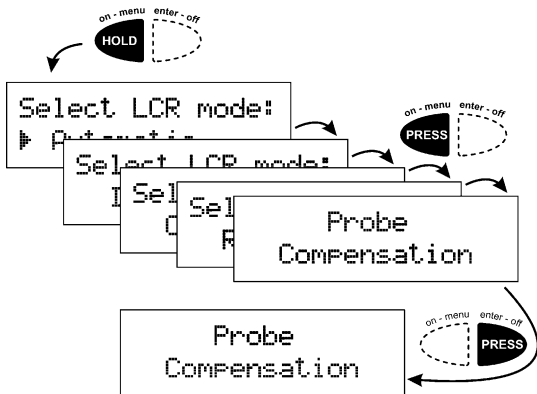

Repeatedly press the **on-menu** button until you see the **Probe Compensation** option, briefly press **enter-off** to select it.

Please note that selecting the Probe Compensation function does not change any operation mode, you'll be returned to your original mode after completing the probe compensation.

Continue to follow the probe compensation instructions on the next page...

Probe compensation continued...

When prompted, attach a small length of tinned copper wire between the two test probes. Now let the leads rest on a non-conductive surface, try not to touch them during the compensation procedure.

```
Short the probes  
then press enter
```

When you're happy that a suitable good link is present between the probes, briefly press the **enter-off** button.



```
Open the probes  
then press enter
```

After a short time, the instrument will ask you to remove the link from the probes.

At that point, remove the link, rest the

probes on a non-conducting surface and don't touch them.

When you've done that you can press **enter-off**.



If the LCR45 is happy with the measurements that it has taken during the probe compensation procedure, you will see the following message:

```
Probe properties  
stored.
```

 Please note that probe compensation is particularly important when analysing low value inductors, capacitors and resistors.

Taking care of your LCR45

Battery Replacement

The LCR45 requires no special maintenance although the battery should be replaced every 12 months to prevent leak damage.

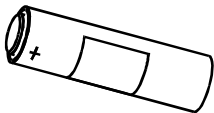

* Low Battery *

If this message is displayed, the battery should be replaced as soon as possible to prevent malfunction or leak damage.

Although the unit may continue to operate following a low battery warning, measurements may be adversely affected.

New batteries can be purchased from many retailers and directly from Peak Electronic Design Ltd or an authorised agent.

Battery types: Suitable battery types include 23A, V23A, GP23A, MN21 or a good quality 12V alkaline equivalent as used in many test instruments and automotive remote key fobs.

Battery access: To replace the battery, unscrew the three screws to remove the rear panel. Remove the old battery and insert a new one, taking care to observe the correct polarity. Carefully replace the rear panel, do not over-tighten the screws.

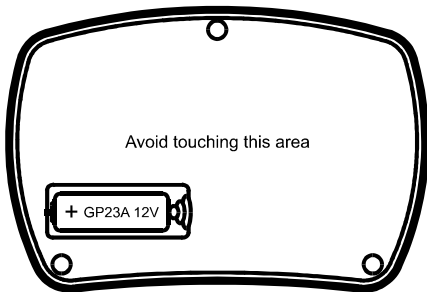

Self Tests

Many internal functions are tested each time the unit is powered up. If any of these self tests do not meet tight performance limits, a message will be displayed similar to the following:

The unit will then switch off.

It is possible that a temporary condition caused the failure and restarting the unit may clear the problem. If the fault

persists please contact Peak Electronic Design Ltd or an authorised agent with details of the error message for further advice.

A rectangular box with a black border containing the text "Error 02" in a monospaced font.A small icon of a pencil pointing upwards and to the right.

Please note that some internal tests cannot be performed if a low battery warning has been displayed. This means that if there is an internal problem, a low battery condition can prevent the error condition from being displayed. It is therefore strongly recommended that a low battery is replaced as soon as a “Low Battery” message is displayed.

Appendix A – Display Units

The LCR45 will display measurement data with the most suitable prefix for the value of parameter being shown. You can convert between unit prefixes using the following tables:

Inductance

μH (micro-Henries)	mH (milli-Henries)	H (Henries)
1	0.001	0.000001
1000	1	0.001
1000 000	1000	1

Capacitance

pF (pico-Farads)	nF (nano-Farads)	μF (micro-Farads)
1	0.001	0.000001
1000	1	0.001
1000 000	1000	1
1000 000 000	1000 000	1000

Resistance

Ω (Ohms)	k Ω (Kilohms)	M Ω (Megohms)
1	0.001	0.000001
1000	1	0.001
1000 000	1000	1

Appendix B – Accessories

A range of useful additions is available to enhance your LCR45.

ATC01 – Single Handheld Case

A smart handheld case that offers great protection for your instrument as well as space for extra probes and battery.

ATC55 – Dual Instrument Case

A specially designed case with custom made foam compartments for up to 2 Peak instruments. The case has a tough exterior, ideal for protecting your LCR45, probes, spare batteries and user guide.

SMD03 – Surface Mount Tweezer Probes

These tweezers are ideal for testing many types of surface mount device. The tweezers can cope with package sizes of 0402, 0603, 0805, 1206, 1210 and Case A/B/C/D.

Fitting is easy: the tweezers are terminated with standard 2mm female connectors.

Other Probe Accessories

Many different probe types are available, specially made for your LCR45. Contact Peak Electronic Design Ltd or an authorised agent for more details.

Further information can be seen here:

http://www.peakelec.co.uk/acatalog/jz_accessories.html

Appendix C – Auto Component Identification Criteria

It is important to appreciate that, in automatic mode, the LCR45 can only decide on the identity of the component under test using results of the electrical tests that it performs on the component.

The LCR45 determines the type of component under test according to the criteria shown here.

If the measured parameters of your component do not suit these criteria, please select a manual mode for your component type.

Inductor and Resistor Detection

The LCR45 will distinguish between components that are largely inductive or largely resistive according to the values of inductance and resistance that it has measured. This is illustrated in the following graph.

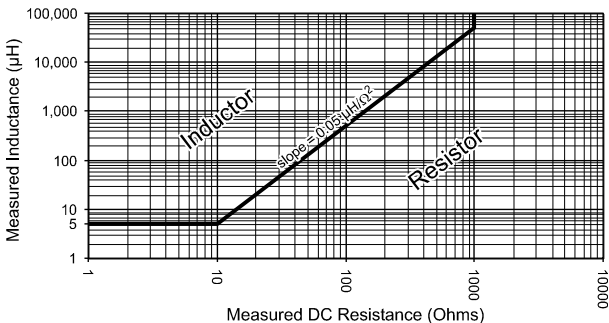

For example, if the inductance of your component is measured at 100µH and it has a DC resistance of 100Ω, then the LCR45 will tell you that you have a resistor. If however the resistance was only 10Ω, then the LCR45 will tell you that you have an inductor.

Note that any inductor with a DC resistance of more than 1000Ω will be identified as a resistor.

Capacitor Detection

The LCR45 will tell you that you have a capacitor if the following criteria are satisfied:

1. If the measured DC resistance is higher than $10\text{M}\Omega$, even if the measured capacitance is very low (such as open probes).

or

2. If the measured DC resistance is between $100\text{k}\Omega$ and $10\text{M}\Omega$ and the measured capacitance is larger than 10pF .

or

3. If the measured DC resistance is between $1\text{k}\Omega$ and $100\text{k}\Omega$ and the measured capacitance is larger than 100nF .

Resistor Detection

Measured characteristics that do not satisfy any of the above criteria (for inductors or capacitors) will be displayed as a resistive element.

These auto-detection criteria are subject to change.

Appendix D – Technical Specifications

Parameter		Min	Typ	Max	Note
Resistance	range	0Ω		2MΩ	
	resolution	0.1 Ω	0.2Ω		
	accuracy	Typically ±1.0% ±0.6 Ω			1,2,6
Capacitance	range	0pF		10,000μF	
	resolution	0.1pF	0.2pF		
	accuracy	Typically ±1.5% ±0.6pF			1,2,5
Inductance	range	0μH		10H	
	resolution	0.1μH	0.2μH		
	accuracy	Typically ±1.5% ±0.6μH			1,2,4
Passive Component Impedance	Re & Im	Typically ±1.5% ±10 LSD			4,5,6
	Magnitude	Typically ±1.5% ±10 LSD			4,5,6
	Phase	Typically ±5°			4,5,6
Measurement Sample Rate		0.5Hz	1.5Hz	2Hz	
Peak test voltage (across O/C)		-1.05V		+1.05V	
Peak test current (thru S/C)		-3.25mA		+3.25mA	
Test frequency accuracy	1kHz	Typically ±0.5%			7
	14.9254kHz				
	200kHz				
Sine purity		Typically -60dB 3 rd harmonic			
Operating temperature range		10°C		40°C	3
Battery operating voltage		8.5V		13V	

Notes:

1. Within 12 months of factory calibration. Please contact us if you require a full re-calibration and/or certification of traceable calibration.
2. Specified at temperatures between 15°C and 30°C.
3. Subject to acceptable LCD visibility.
4. For inductances between 100μH and 100mH in fully auto mode.
5. For capacitances between 200pF and 500nF in fully auto mode.
6. For resistances between 10Ω and 1MΩ in fully auto mode.
7. For clarity, the 14.9254kHz test frequency is shown as 15kHz.

Appendix E – Troubleshooting

Problem	Possible Solution
Capacitance measured when probes are open circuit is not close to zero ($\pm 1.0\text{pF}$).	Perform a probe compensation.
Resistance and/or inductance measured when probes are short circuit is not close to zero ($\pm 1.2\Omega$, $\pm 1.6\mu\text{H}$).	Perform a probe compensation.
Component shown as Ind/Res	Components with an inductance of $<10\mu\text{H}$ and resistance of $<10\Omega$ will be shown as an Inductor/Resistor because it is not always possible to measure a discernable difference at the test frequencies used.
Measured value doesn't appear to be correct.	Ensure probes are well connected to the component under test for a few seconds and allow the readings to settle.
	Ensure that nothing else is connected with the component under test. Make sure that you are not touching the connections.
	The LCR45 may have selected a mode that is not optimum for your component, try a manual mode.
	The component value may be outside the supported measurement range.
	The component's design frequency may not correspond to the test frequencies used by the LCR45.
Measured values vary between readings.	The displayed resolution is higher than the internal measurement resolution to avoid rounding errors. Variations within the quoted measurement resolutions are normal.
Calibration date is approaching or has past.	Your LCR45 will carry on working after the "Calibration Due Date" has past. The date is simply a recommendation.

Appendix F – Statutory Information

Peak Warranty

If for any reason you are not completely satisfied with the LCR45 within 14 days of purchase, you may return the unit to your distributor. You will receive a refund covering the full purchase price if the unit is returned in perfect condition.

The warranty is valid for 24 months from date of purchase. This warranty covers the cost of repair or replacement due to defects in materials and/or manufacturing faults.

The warranty does not cover malfunction or defects caused by:

- Operation outside the scope of the user guide.
- Unauthorised access or modification of the unit (except for battery replacement).
- Accidental physical damage or abuse.
- Normal wear and tear.

The customer's statutory rights are not affected by any of the above. All claims must be accompanied by a proof of purchase.



WEEE (Waste of Electrical and Electronic Equipment), Recycling of Electrical and Electronic Products

In 2006 the European Union introduced regulations (WEEE) for the collection and recycling of all waste electrical and electronic equipment. It is no longer permissible to simply throw away electrical and electronic equipment. Instead, these products must enter the recycling process. Each individual EU member state has implemented the WEEE regulations into national law in slightly different ways. Please follow your national law when you want to dispose of any electrical or electronic products. **More details can be obtained from your national WEEE recycling agency.**

At Peak Electronic Design Ltd we are committed to continual product development and improvement. The specifications of our products are therefore subject to change without notice.

© 2002-2014 Peak Electronic Design Limited - E&OE
Designed and manufactured in the UK
www.peakelec.co.uk Tel. +44 (0) 1298 70012 Fax. +44 (0) 1298 70046